

**PIATTAFORME AUTOSOLLEVANTI mod. MBP 01/150 e MBP 02/150**

**PLATE-FORMES DE TRAVAIL mod. MBP 01/150 et MBP 02/150**

**MAST WORKING PLATFORMS mod. MBP 01/150 and MBP 02/150**



**CONFIGURAZIONI DI MONTAGGIO  
CONFIGURATIONS DE MONTAGE  
ERECTION CONFIGURATIONS**

**ATTENZIONE** OGNI SCHEMA DI MONTAGGIO DEVE ESSERE  
VERIFICATO DA PARTE DI UN TECNICO ABILITATO

**ATTENTION** CHAQUE PLAN DE MONTAGE DOIT ETRE VERIFIE  
PAR UN TECHNICIEN CERTIFIE

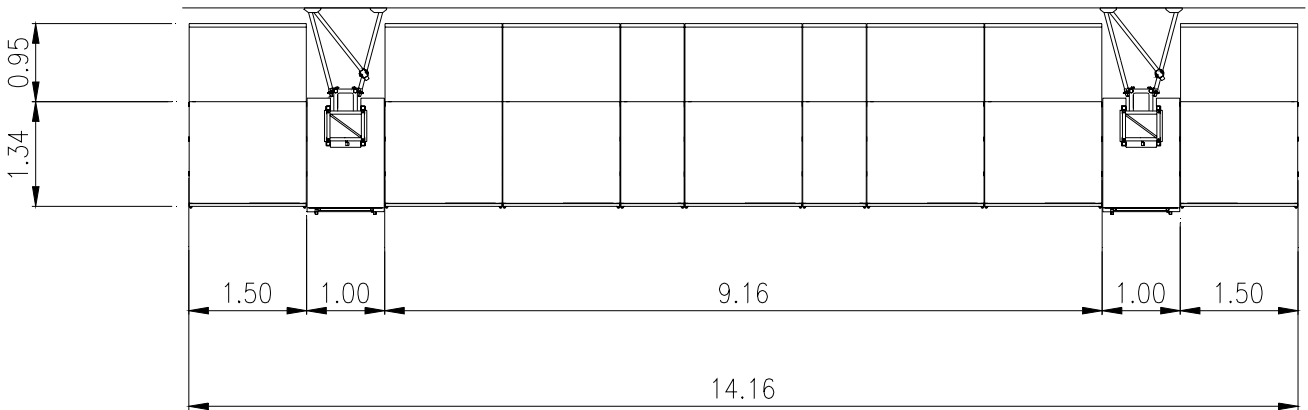
**CAUTION** EVERY ERECTION PATTERN MUST BE CHECKED BY A  
QUALIFIED TECHNICIAN

**ESEMPIO – EXEMPLE – EXAMPLE N° 1 MBP 02/150**

**DESCRIZIONE – DESCRIPTION:**

PORTATA MAX:	2500 KG	INCLUDE MAX	
MAX CAPACITÉ:	2500 KG	MAX INCLUES	
MAX CAPACITY:	2500 KG	MAX INCLUDED	
MAX TRAGFÄHIGKEIT:	2500 KG	MAX MIT	

**ATTENZIONE** OGNI SCHEMA DI MONTAGGIO DEVE ESSERE VERIFICATO DA PARTE DI UN TECNICO ABILITATO

**ATTENTION** CHAQUE PLAN DE MONTAGE DOIT ETRE VERIFIE PAR UN TECHNICIEN CERTIFIE

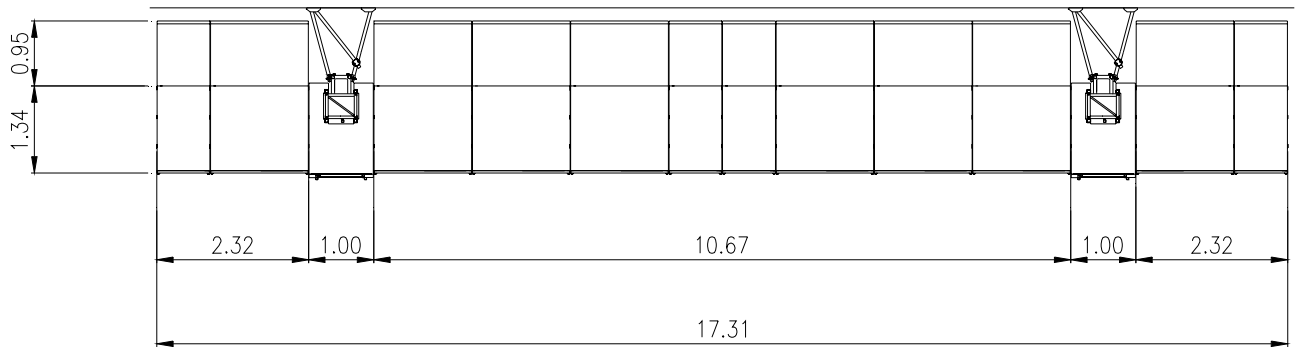
**CAUTION** EVERY ERECTION PATTERN MUST BE CHECKED BY A QUALIFIED TECHNICIAN

**ESEMPIO - EXEMPLE- EXAMPLE N° 2 MBP 02/150**

**DESCRIZIONE – DESCRIPTION:**

PORTATA MAX:	2200 KG	INCLUDE MAX	
MAX CAPACITÉ:	2200 KG	MAX INCLUES	
MAX CAPACITY:	2200 KG	MAX INCLUDED	
MAX TRAGFÄHIGKEIT:	2200 KG	MAX MIT	

**ATTENZIONE** OGNI SCHEMA DI MONTAGGIO DEVE ESSERE VERIFICATO DA PARTE DI UN TECNICO ABILITATO

**ATTENTION** CHAQUE PLAN DE MONTAGE DOIT ETRE VERIFIE PAR UN TECHNICIEN CERTIFIE

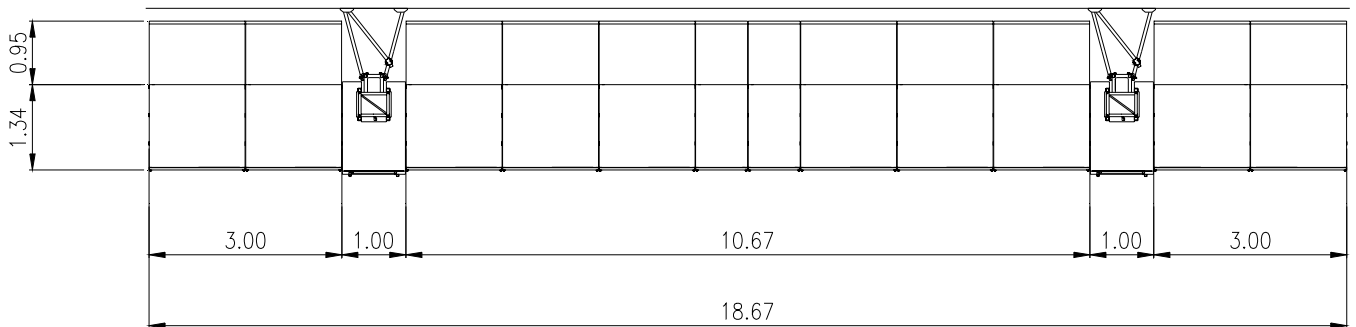
**CAUTION** EVERY ERECTION PATTERN MUST BE CHECKED BY A QUALIFIED TECHNICIAN

**ESEMPIO - EXEMPLE- EXAMPLE N° 3 MBP 02/150**

**DESCRIZIONE – DESCRIPTION:**

PORTATA MAX:	2000 KG	INCLUDE MAX	
MAX CAPACITÉ:	2000 KG	MAX INCLUES	
MAX CAPACITY:	2000 KG	MAX INCLUDED	
MAX TRAGFÄHIGKEIT:	2000 KG	MAX MIT	

**ATTENZIONE** OGNI SCHEMA DI MONTAGGIO DEVE ESSERE VERIFICATO DA PARTE DI UN TECNICO ABILITATO

**ATTENTION** CHAQUE PLAN DE MONTAGE DOIT ETRE VERIFIE PAR UN TECHNICIEN CERTIFIE

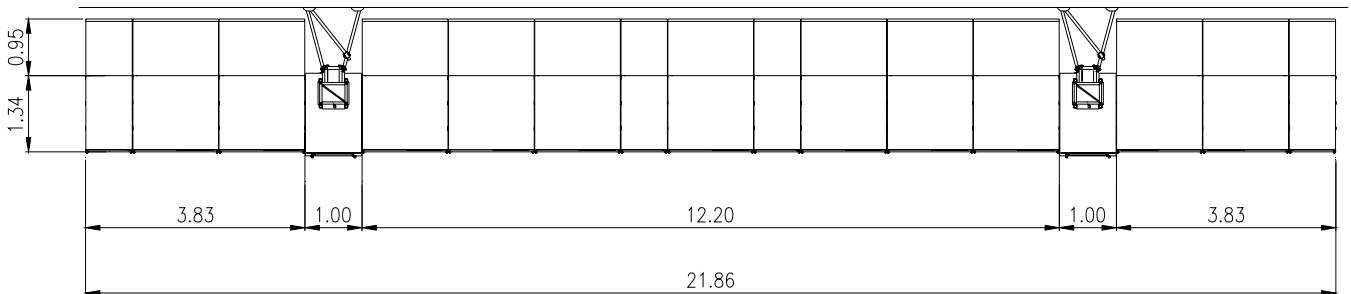
**CAUTION** EVERY ERECTION PATTERN MUST BE CHECKED BY A QUALIFIED TECHNICIAN

**ESEMPIO - EXEMPLE- EXAMPLE N° 4 MBP 02/150**

**DESCRIZIONE – DESCRIPTION:**

PORTATA MAX:	1800 KG	INCLUDE MAX	
MAX CAPACITÉ:	1800 KG	MAX INCLUES	
MAX CAPACITY:	1800 KG	MAX INCLUDED	
MAX TRAGFÄHIGKEIT:	1800 KG	MAX MIT	

**ATTENZIONE** OGNI SCHEMA DI MONTAGGIO DEVE ESSERE VERIFICATO DA PARTE DI UN TECNICO ABILITATO

**ATTENTION** CHAQUE PLAN DE MONTAGE DOIT ETRE VERIFIE PAR UN TECHNICIEN CERTIFIE

**CAUTION** EVERY ERECTION PATTERN MUST BE CHECKED BY A QUALIFIED TECHNICIAN

**ESEMPIO - EXEMPLE- EXAMPLE N° 5 MBP 02/150**

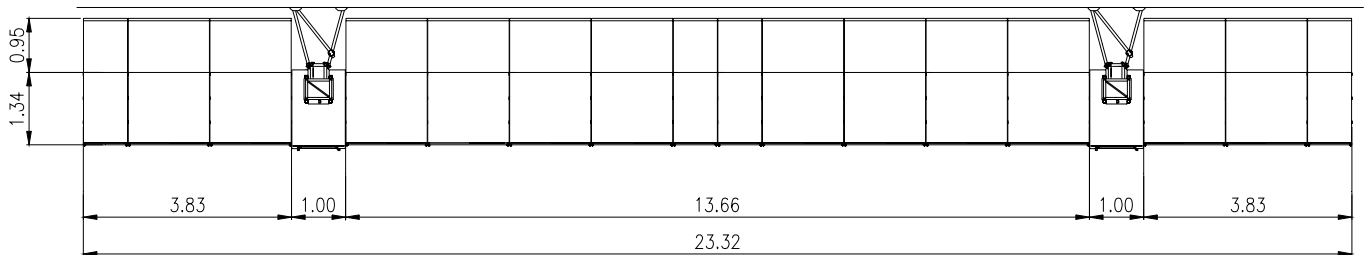

**DESCRIZIONE – DESCRIPTION:**

PORTATA MAX:	1600 KG	INCLUDE MAX	
MAX CAPACITÉ:	1600 KG	MAX INCLUES	
MAX CAPACITY:	1600 KG	MAX INCLUDED	
MAX TRAGFÄHIGKEIT:	1600 KG	MAX MIT	

**ATTENZIONE** OGNI SCHEMA DI MONTAGGIO DEVE ESSERE VERIFICATO DA PARTE DI UN TECNICO ABILITATO

**ATTENTION** CHAQUE PLAN DE MONTAGE DOIT ETRE VERIFIE PAR UN TECHNICIEN CERTIFIE

**CAUTION** EVERY ERECTION PATTERN MUST BE CHECKED BY A QUALIFIED TECHNICIAN

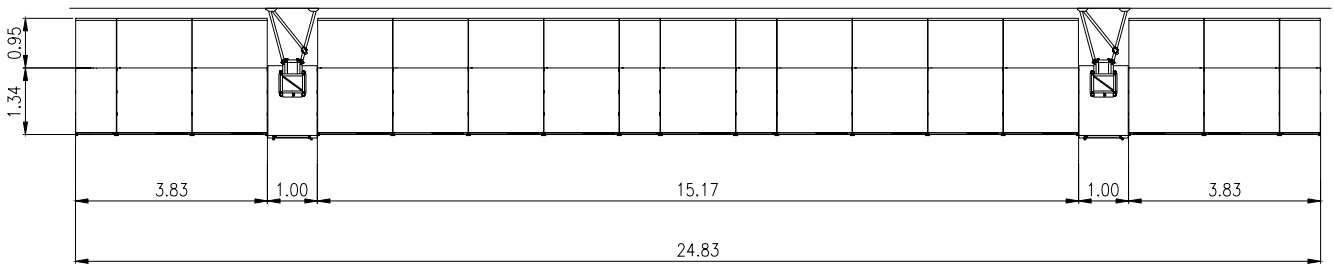
**ESEMPIO - EXEMPLE- EXAMPLE N° 6 MBP 02/150**

**DESCRIZIONE – DESCRIPTION:**

PORTATA MAX:	1400 KG	INCLUDE MAX	
MAX CAPACITÉ:	1400 KG	MAX INCLUES	
MAX CAPACITY:	1400 KG	MAX INCLUDED	
MAX TRAGFÄHIGKEIT:	1400 KG	MAX MIT	

**ATTENZIONE** OGNI SCHEMA DI MONTAGGIO DEVE ESSERE VERIFICATO DA PARTE DI UN TECNICO ABILITATO

**ATTENTION** CHAQUE PLAN DE MONTAGE DOIT ETRE VERIFIE PAR UN TECHNICIEN CERTIFIE

**CAUTION** EVERY ERECTION PATTERN MUST BE CHECKED BY A QUALIFIED TECHNICIAN

**ESEMPIO - EXEMPLE- EXAMPLE N° 7 MBP 02/150**

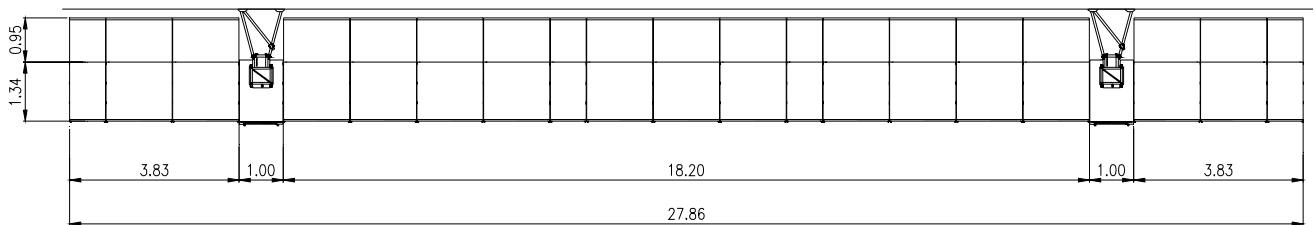

**DESCRIZIONE – DESCRIPTION:**

PORTATA MAX:	1200 KG	INCLUDE MAX	
MAX CAPACITÉ:	1200 KG	MAX INCLUES	
MAX CAPACITY:	1200 KG	MAX INCLUDED	
MAX TRAGFÄHIGKEIT:	1200 KG	MAX MIT	

**ATTENZIONE** OGNI SCHEMA DI MONTAGGIO DEVE ESSERE VERIFICATO DA PARTE DI UN TECNICO ABILITATO

**ATTENTION** CHAQUE PLAN DE MONTAGE DOIT ETRE VERIFIE PAR UN TECHNICIEN CERTIFIE

**CAUTION** EVERY ERECTION PATTERN MUST BE CHECKED BY A QUALIFIED TECHNICIAN

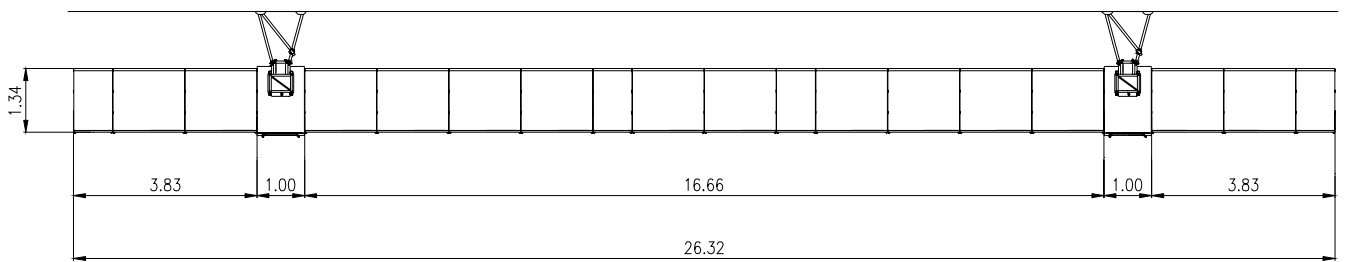

**ESEMPIO - EXEMPLE- EXAMPLE N° 8 MBP 02/150**

**DESCRIZIONE – DESCRIPTION:**

PORTATA MAX:	1400 KG	INCLUDE MAX	
MAX CAPACITÉ:	1400 KG	MAX INCLUES	
MAX CAPACITY:	1400 KG	MAX INCLUDED	
MAX TRAGFÄHIGKEIT:	1400 KG	MAX MIT	

**ATTENZIONE** OGNI SCHEMA DI MONTAGGIO DEVE ESSERE VERIFICATO DA PARTE DI UN TECNICO ABILITATO

**ATTENTION** CHAQUE PLAN DE MONTAGE DOIT ETRE VERIFIE PAR UN TECHNICIEN CERTIFIE

**CAUTION** EVERY ERECTION PATTERN MUST BE CHECKED BY A QUALIFIED TECHNICIAN

**ESEMPIO - EXEMPLE- EXAMPLE N° 9 MBP 02/150**

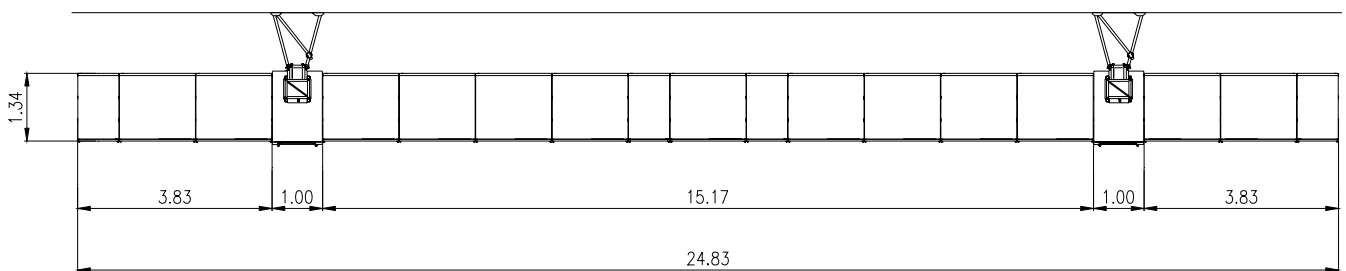

**DESCRIZIONE – DESCRIPTION:**

PORTATA MAX:	1600 KG	INCLUDE MAX	
MAX CAPACITÉ:	1600 KG	MAX INCLUES	
MAX CAPACITY:	1600 KG	MAX INCLUDED	
MAX TRAGFÄHIGKEIT:	1600 KG	MAX MIT	

**ATTENZIONE** OGNI SCHEMA DI MONTAGGIO DEVE ESSERE VERIFICATO DA PARTE DI UN TECNICO ABILITATO

**ATTENTION** CHAQUE PLAN DE MONTAGE DOIT ETRE VERIFIE PAR UN TECHNICIEN CERTIFIE

**CAUTION** EVERY ERECTION PATTERN MUST BE CHECKED BY A QUALIFIED TECHNICIAN

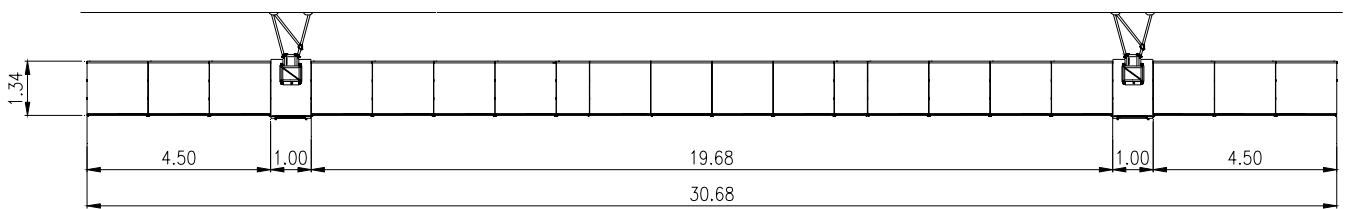
**ESEMPIO - EXEMPLE- EXAMPLE N° 10 MBP 02/150**

**DESCRIZIONE – DESCRIPTION:**

PORTATA MAX:	600 KG	INCLUDE MAX	
MAX CAPACITÉ:	600 KG	MAX INCLUES	
MAX CAPACITY:	600 KG	MAX INCLUDED	
MAX TRAGFÄHIGKEIT:	600 KG	MAX MIT	

**ATTENZIONE** MONTARE OBBLIGATORIAMENTE GLI ANCORAGGI OGNI 6 m.

**ATTENTION** LES ANCRAGES DOIVENT ETRE FIXES TOUS LES 6 m.

**WARNING** TIES MUST BE FIXED EVERY 6 m.

**ATTENZIONE** OGNI SCHEMA DI MONTAGGIO DEVE ESSERE VERIFICATO DA PARTE DI UN TECNICO ABILITATO

**ATTENTION** CHAQUE PLAN DE MONTAGE DOIT ETRE VERIFIE PAR UN TECHNICIEN CERTIFIE

**CAUTION** EVERY ERECTION PATTERN MUST BE CHECKED BY A QUALIFIED TECHNICIAN

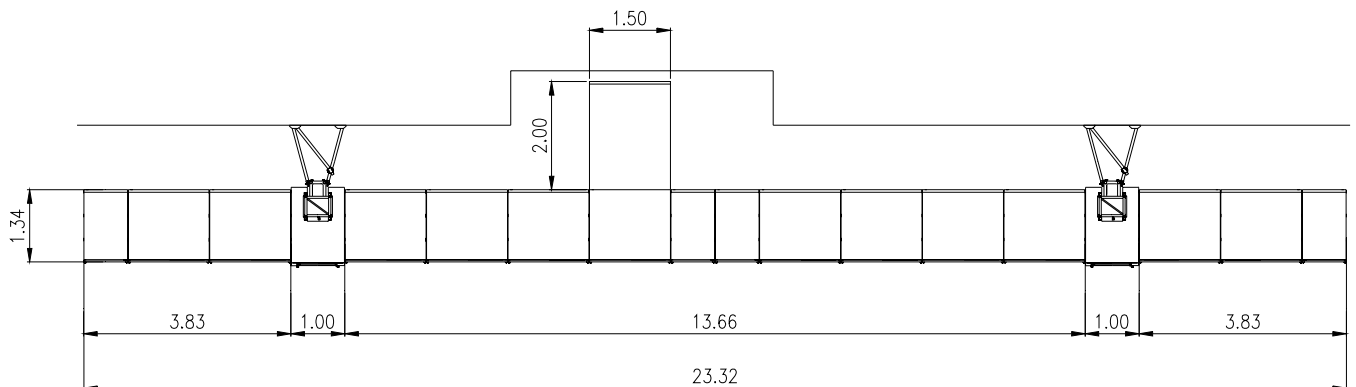
**ESEMPIO - EXEMPLE- EXAMPLE N° 11 MBP 02/150**

**DESCRIZIONE – DESCRIPTION:**

PORTATA MAX:	1000 KG	INCLUDE MAX	
MAX CAPACITÉ:	1000 KG	MAX INCLUES	
MAX CAPACITY:	1000 KG	MAX INCLUDED	
MAX TRAGFÄHIGKEIT:	1000 KG	MAX MIT	

**ATTENZIONE:** SUGLI SBALZI VERSO LA PARETE, LUNGHY 2 METRI, PUO' SALIRE AL MASSIMO 1 PERSONA. SBALZI LARGHEZZA MAX 1.50 METRI.

**ATTENTION:** SUR LES EXTENSIONS VERS LE MUR, LONGUES 2 m., 1 PERSONNE AU MAXIMUM PEUX MONTER. EXTENSIONS LARGEUR MAX 1.50 m.



**WARNING:** ON THE 2 m. LONG EXTENSIONS TOWARDS THE WALL, MAX 1 PERSON CAN STAY.

**ATTENZIONE** OGNI SCHEMA DI MONTAGGIO DEVE ESSERE VERIFICATO DA PARTE DI UN TECNICO ABILITATO

**ATTENTION** CHAQUE PLAN DE MONTAGE DOIT ETRE VERIFIE PAR UN TECHNICIEN CERTIFIE

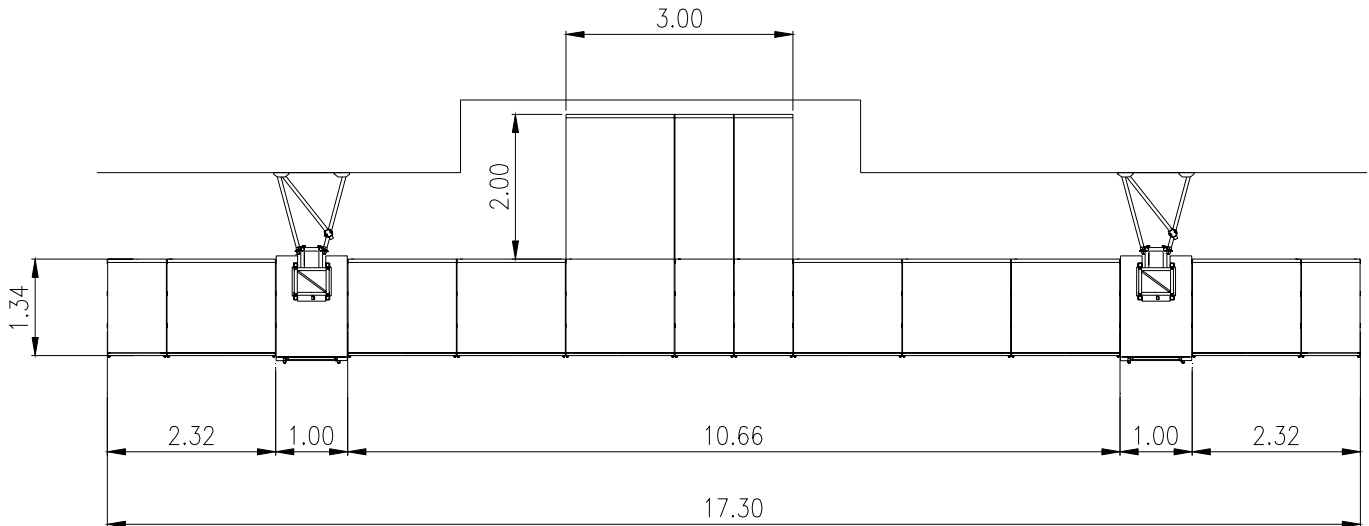
**CAUTION** EVERY ERECTION PATTERN MUST BE CHECKED BY A QUALIFIED TECHNICIAN

**ESEMPIO - EXEMPLE- EXAMPLE N° 12 MBP 02/150**

**DESCRIZIONE – DESCRIPTION:**

PORTATA MAX:	1200 KG	INCLUDE MAX	
MAX CAPACITÉ:	1200 KG	MAX INCLUES	
MAX CAPACITY:	1200 KG	MAX INCLUDED	
MAX TRAGFÄHIGKEIT:	1200 KG	MAX MIT	

**ATTENZIONE** SUGLI SBALZI VERSO LA PARETE, LUNGI 2 METRI, PUO' SALIRE AL MASSIMO 1 PERSONA.  
**ATTENTION** SUR LES EXTENSIONS VERS LE MUR, LONGUES 2 m., 1 PERSONNE AU MAXIMUM PEUX MONTER.

**WARNING** ON THE 2 m. LONG EXTENSIONS TOWARDS THE WALL, MAX 1 PERSON CAN STAY.

**ATTENZIONE** OGNI SCHEMA DI MONTAGGIO DEVE ESSERE VERIFICATO DA PARTE DI UN TECNICO ABILITATO

**ATTENTION** CHAQUE PLAN DE MONTAGE DOIT ETRE VERIFIE PAR UN TECHNICIEN CERTIFIE

**CAUTION** EVERY ERECTION PATTERN MUST BE CHECKED BY A QUALIFIED TECHNICIAN

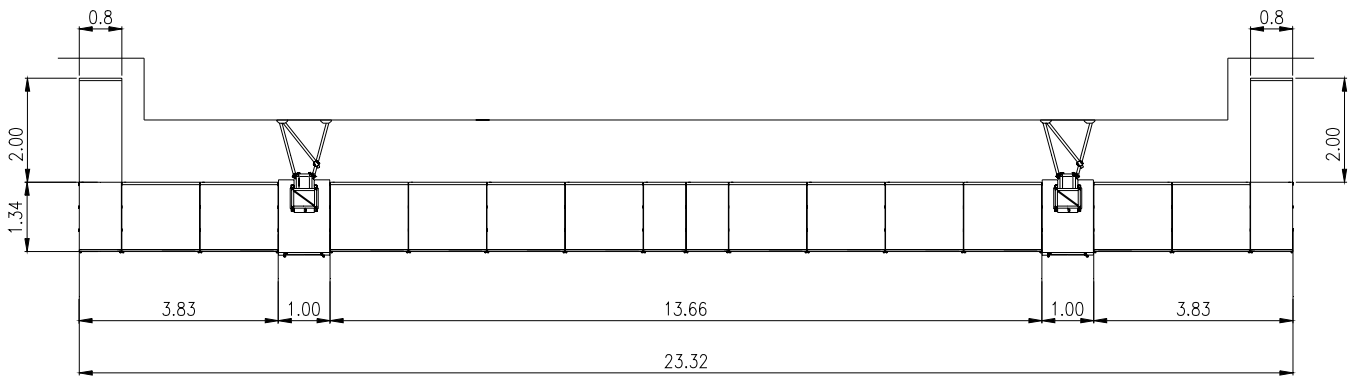
**ESEMPIO - EXEMPLE- EXAMPLE N° 13 MBP 02/150**

**DESCRIZIONE – DESCRIPTION:**

PORTATA MAX:	1600 KG	INCLUDE MAX	
MAX CAPACITÉ:	1600 KG	MAX INCLUES	
MAX CAPACITY:	1600 KG	MAX INCLUDED	
MAX TRAGFÄHIGKEIT:	1600 KG	MAX MIT	

**ATTENZIONE** SUGLI SBALZI VERSO LA PARETE, LUNGI 2 METRI, PUO' SALIRE AL MASSIMO 1 PERSONA.  
**ATTENTION** SUR LES EXTENSIONS VERS LE MUR, LONGUES 2 m., 1 PERSONNE AU MAXIMUM PEUX MONTER.

**WARNING** ON THE 2 m. LONG EXTENSIONS TOWARDS THE WALL, MAX 1 PERSON CAN STAY.

**ATTENZIONE** OGNI SCHEMA DI MONTAGGIO DEVE ESSERE VERIFICATO DA PARTE DI UN TECNICO ABILITATO

**ATTENTION** CHAQUE PLAN DE MONTAGE DOIT ETRE VERIFIE PAR UN TECHNICIEN CERTIFIE

**CAUTION** EVERY ERECTION PATTERN MUST BE CHECKED BY A QUALIFIED TECHNICIAN

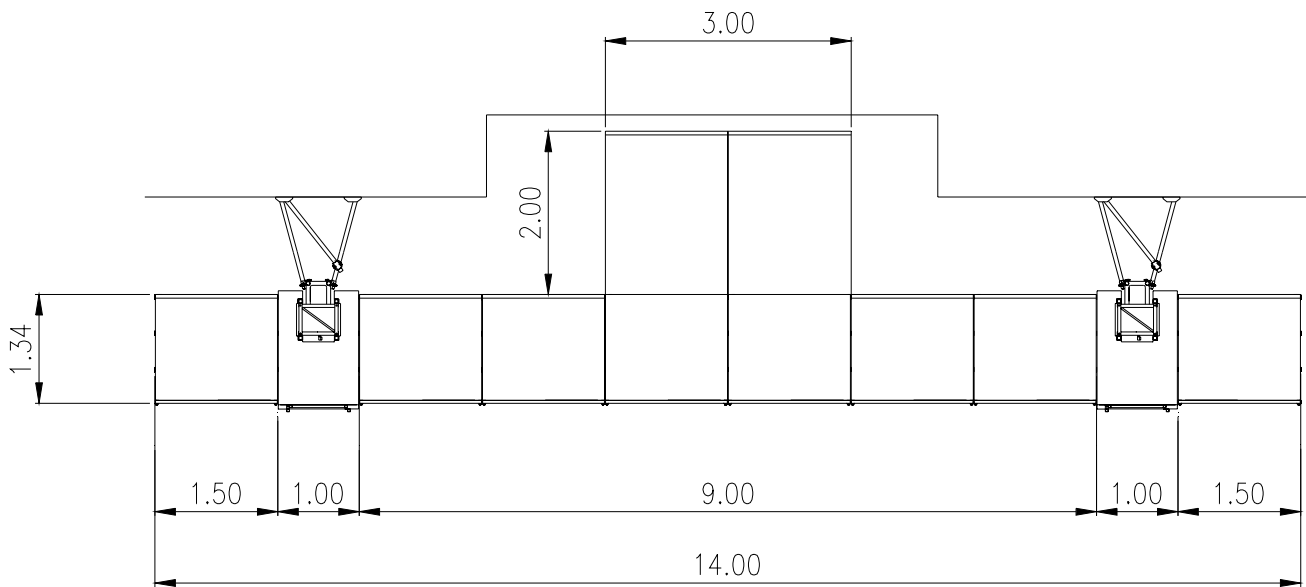
**ESEMPIO - EXEMPLE- EXAMPLE N° 14 MBP 02/150**

**DESCRIZIONE – DESCRIPTION:**

PORTATA MAX:	1400 KG	INCLUDE MAX	   
MAX CAPACITÉ:	1400 KG	MAX INCLUES	   
MAX CAPACITY:	1400 KG	MAX INCLUDED	   
MAX TRAGFÄHIGKEIT:	1400 KG	MAX MIT	   

**ATTENZIONE** SUGLI SBALZI VERSO LA PARETE, LUNGHI 2 METRI, PUO' SALIRE AL MASSIMO 1 PERSONA.  
**ATTENTION** SUR LES EXTENSIONS VERS LE MUR, LONGUES 2 m., 1 PERSONNE AU MAXIMUM PEUX MONTER.

**WARNING** ON THE 2 m. LONG EXTENSIONS TOWARDS THE WALL, MAX 1 PERSON CAN STAY.

**ATTENZIONE** OGNI SCHEMA DI MONTAGGIO DEVE ESSERE VERIFICATO DA PARTE DI UN TECNICO ABILITATO

**ATTENTION** CHAQUE PLAN DE MONTAGE DOIT ETRE VERIFIE PAR UN TECHNICIEN CERTIFIE

**CAUTION** EVERY ERECTION PATTERN MUST BE CHECKED BY A QUALIFIED TECHNICIAN

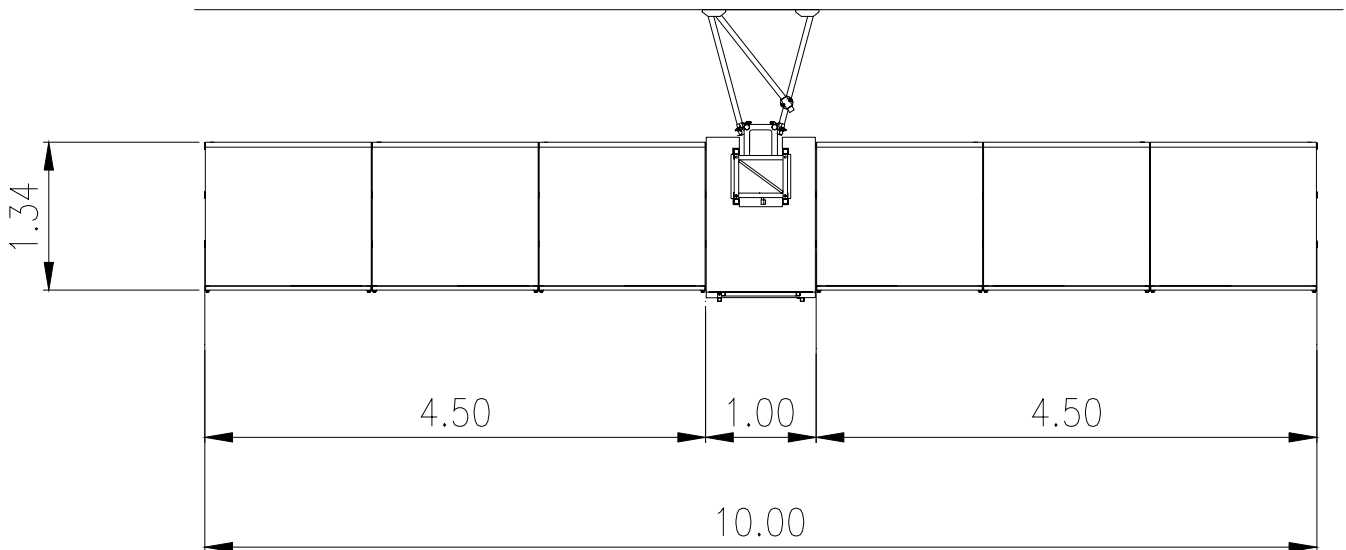
**ESEMPIO - EXEMPLE- EXAMPLE N° 15 MBP 01/150**

**DESCRIZIONE – DESCRIPTION:**

PORTATA MAX:	500 KG	INCLUDE MAX	
MAX CAPACITÉ:	500 KG	MAX INCLUES	
MAX CAPACITY:	500 KG	MAX INCLUDED	
MAX TRAGFÄHIGKEIT:	500 KG	MAX MIT	

**ATTENZIONE** OGNI SCHEMA DI MONTAGGIO DEVE ESSERE VERIFICATO DA PARTE DI UN TECNICO ABILITATO

**ATTENTION** CHAQUE PLAN DE MONTAGE DOIT ETRE VERIFIE PAR UN TECHNICIEN CERTIFIE

**CAUTION** EVERY ERECTION PATTERN MUST BE CHECKED BY A QUALIFIED TECHNICIAN

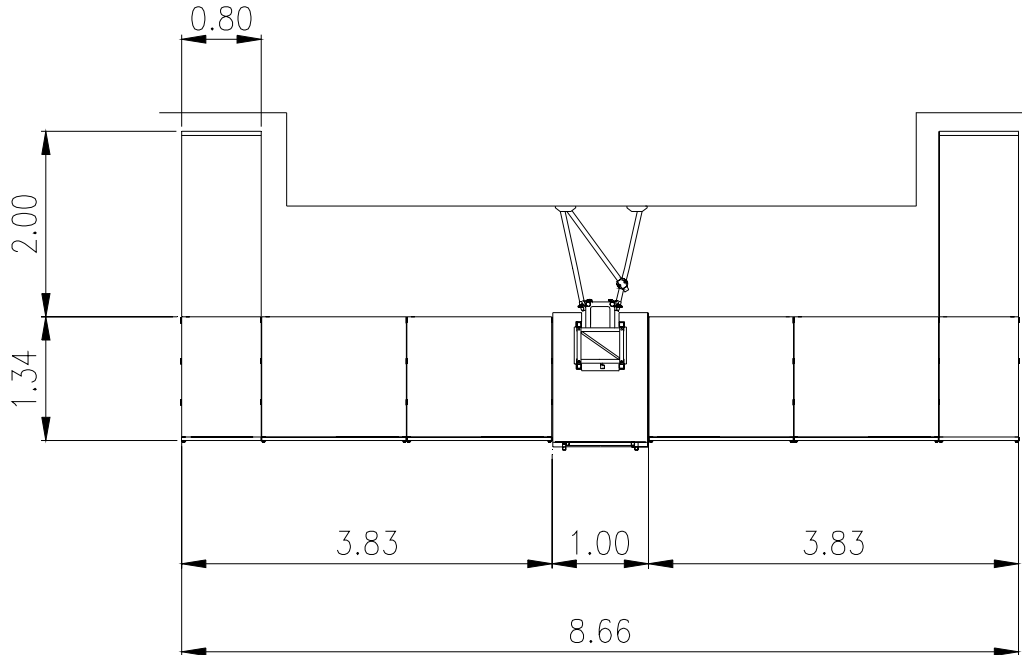

**ESEMPIO - EXEMPLE- EXAMPLE N° 16 MBP 01/150**

**DESCRIZIONE – DESCRIPTION:**

PORTATA MAX:	800 KG	INCLUDE MAX	
MAX CAPACITÉ:	800 KG	MAX INCLUES	
MAX CAPACITY:	800 KG	MAX INCLUDED	
MAX TRAGFÄHIGKEIT:	800 KG	MAX MIT	

**ATTENZIONE** SUGLI SBALZI VERSO LA PARETE, LUNGI 2 METRI, PUO' SALIRE AL MASSIMO 1 PERSONA.  
**ATTENTION** SUR LES EXTENSIONS VERS LE MUR, LONGUES 2 m., 1 PERSONNE AU MAXIMUM PEUX MONTER.





**WARNING** ON THE 2 m. LONG EXTENSIONS TOWARDS THE WALL, MAX 1 PERSON CAN STAY.

**ATTENZIONE** OGNI SCHEMA DI MONTAGGIO DEVE ESSERE VERIFICATO DA PARTE DI UN TECNICO ABILITATO

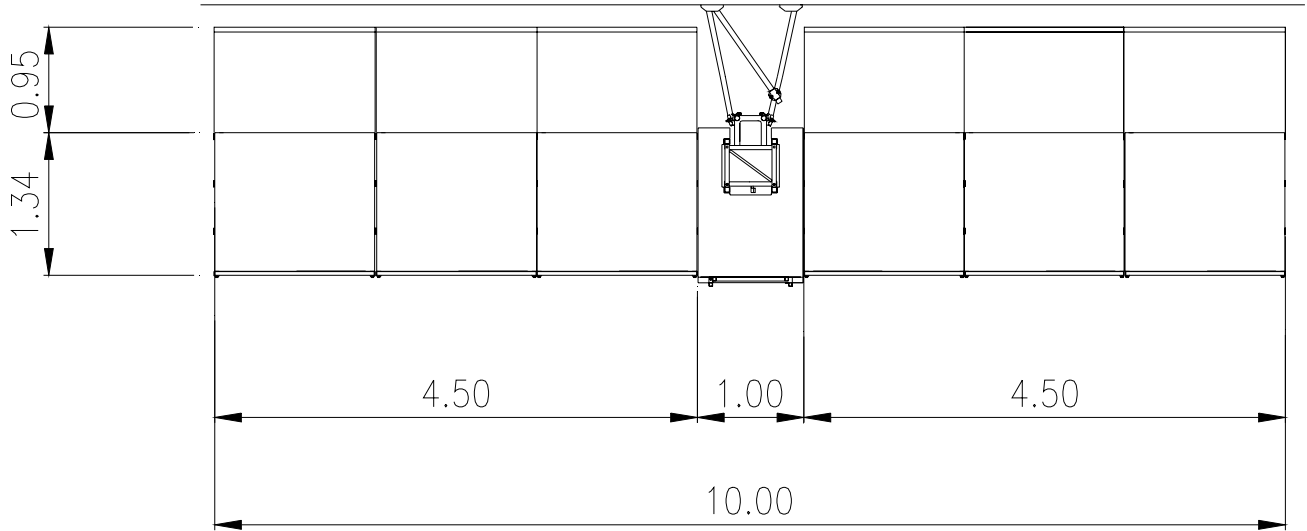
**ATTENTION** CHAQUE PLAN DE MONTAGE DOIT ETRE VERIFIE PAR UN TECHNICIEN CERTIFIE

**CAUTION** EVERY ERECTION PATTERN MUST BE CHECKED BY A QUALIFIED TECHNICIAN

**ESEMPIO - EXEMPLE- EXAMPLE N° 17 MBP 01/150**

**DESCRIZIONE – DESCRIPTION:**

PORTATA MAX:	500 KG	INCLUDE MAX	
MAX CAPACITÉ:	500 KG	MAX INCLUES	
MAX CAPACITY:	500 KG	MAX INCLUDED	
MAX TRAGFÄHIGKEIT:	500 KG	MAX MIT	

**ATTENZIONE** MONTARE OBBLIGATORIAMENTE GLI ANCORAGGI OGNI 6 m.  
**ATTENTION** LES ANCRAGES DOIVENT ETRE FIXES TOUS LES 6 m.  
**WARNING** TIES MUST BE FIXED EVERY 6 m.

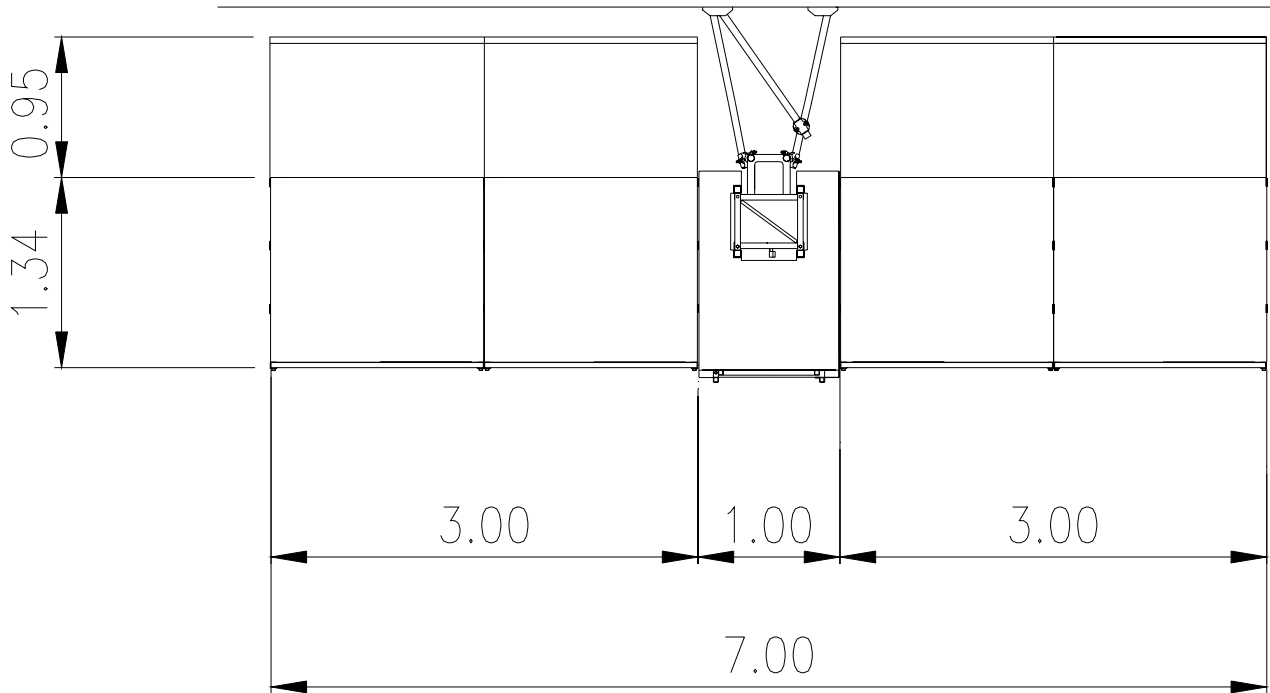
**ATTENZIONE** OGNI SCHEMA DI MONTAGGIO DEVE ESSERE VERIFICATO DA PARTE DI UN TECNICO ABILITATO  
**ATTENTION** CHAQUE PLAN DE MONTAGE DOIT ETRE VERIFIE PAR UN TECHNICIEN CERTIFIE  
**CAUTION** EVERY ERECTION PATTERN MUST BE CHECKED BY A QUALIFIED TECHNICIAN

**ESEMPIO - EXEMPLE- EXAMPLE N° 18 MBP 01/150**

**DESCRIZIONE – DESCRIPTION:**

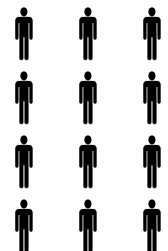
PORTATA MAX:	1000 KG	INCLUDE MAX
MAX CAPACITÉ:	1000 KG	MAX INCLUES
MAX CAPACITY:	1000 KG	MAX INCLUDED
MAX TRAGFÄHIGKEIT:	1000 KG	MAX MIT





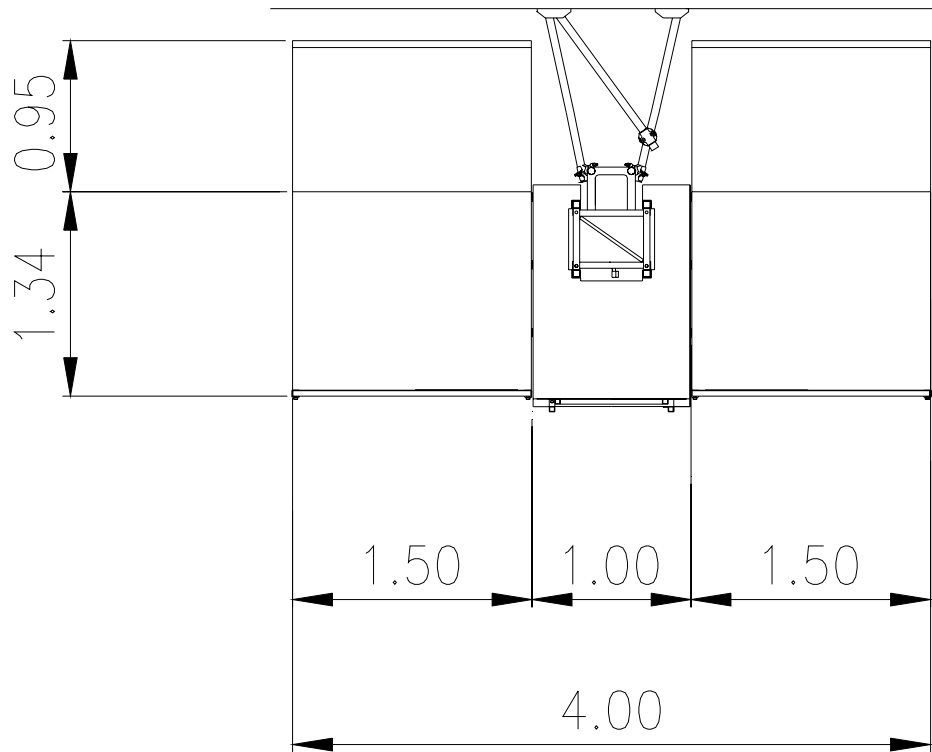

**ATTENZIONE** OGNI SCHEMA DI MONTAGGIO DEVE ESSERE VERIFICATO DA PARTE DI UN TECNICO ABILITATO

**ATTENTION** CHAQUE PLAN DE MONTAGE DOIT ETRE VERIFIE PAR UN TECHNICIEN CERTIFIE

**CAUTION** EVERY ERECTION PATTERN MUST BE CHECKED BY A QUALIFIED TECHNICIAN

**ESEMPIO - EXEMPLE- EXAMPLE N° 19 MBP 01/150**

**DESCRIZIONE – DESCRIPTION:**

PORTATA MAX:	1200 KG	INCLUDE MAX	
MAX CAPACITÉ:	1200 KG	MAX INCLUES	
MAX CAPACITY:	1200 KG	MAX INCLUDED	
MAX TRAGFÄHIGKEIT:	1200 KG	MAX MIT	

**ATTENZIONE** OGNI SCHEMA DI MONTAGGIO DEVE ESSERE VERIFICATO DA PARTE DI UN TECNICO ABILITATO

**ATTENTION** CHAQUE PLAN DE MONTAGE DOIT ETRE VERIFIE PAR UN TECHNICIEN CERTIFIE

**CAUTION** EVERY ERECTION PATTERN MUST BE CHECKED BY A QUALIFIED TECHNICIAN